



**Dedicated  
Serving  
System**

# **DS-MR20/VI**

## **MOBILE REFRIGERATED CART**

### **General Specifications & Features**

- #304 Stainless steel interior & exterior.
- Bottom-mounted high ambient 43°C refrigeration system, using R134a refrigerant, generating 1584 BTU (399 Kcal) per hour.
- Ultra low energy consumption.
- Zero ODP injected polyurethane insulation for environmental protection.
- Factory preset refrigerator temperature at +1 / +4°C.
- Electronic controller with a large LCD display.
- Audio visual temperature alarms come as standard, along with HACCP capability.
- Automatic defrost (hot gas defrost – refrigerator) to help minimizing service needs.
- Coated evaporator and vaporiser coil.
- Safety cut out switch – heated.
- Color-coded control panel (in blue color for the refrigerated cart) for easy identification of the purpose of the cart.
- Interior curved corners/edges for easy cleaning and hygiene & sanitation purpose.
- Gastronorm shelving system with anti-tilt slides.
- Mechanical parts are easily accessible for quick servicing & maintenance.
- Four (4) integrated stylish door handles on each side of the cart for easy transportation.
- Door handle is equipped with lock.
- Four (4) heavy-duty swivel castors.
- Full-perimeter bumper guard to ensure heavy duty use and protection.
- Designed to adapt to 1/1 GN pans or 1/2 GN pans. This model is quite practical and suitable for catering & banqueting services.



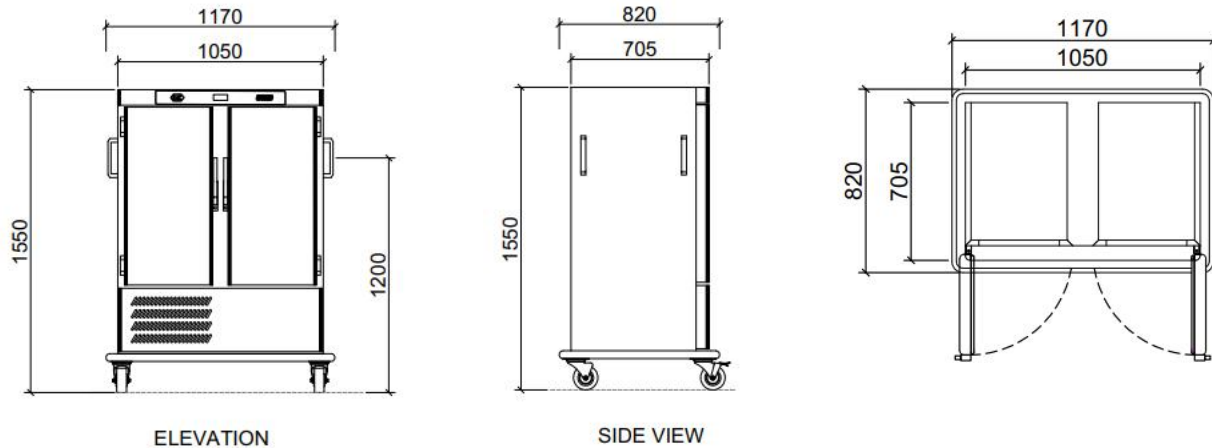

## Technical Specifications

Model	Pan / Product Capacity	Temperature	Refrigerant	Voltage	Phase	Cycle	Amps	Watts	Cord Length
DS-MR20/VI	(20) 1/1 GN pans or (40) 1/2 GN pans	+1 / +4°C	R134A	220-240V	1	50/60 Hz	2.5	317	2.5M

## Dimensions & Weights

Interior Dimensions (W x D x H in mm)	Exterior Dimensions (W x D x H in mm)	Product Net Weight (kg)	Shipping Dimensions with Standard Packing (W x D x H in mm)	Shipping Weight with Standard Packing (kg)	Shipping Dimensions with Wooden Crating (W x D x H in mm)	Shipping Weight with Wooden Crating (kg)
970 x 655 x 950	1170 x 820 x 1550	155	1175 x 825 x 1600	160	1220 x 870 x 1700	190

### INSTALLATION REQUIREMENTS

- Cart must be installed level.
- Cart must not be installed in any area where it may be affected by steam, grease, dripping water, extreme temperatures, or any other severely adverse conditions.

### CLEARANCE REQUIREMENTS

Full perimeter bumper accommodates all clearance requirements.

*Note: Three (3) years international warranty on parts.*



DK Resources International Ltd

Marketed & Distributed by:

DK Resources International Ltd.

Tel: +852 68906866; +65 90180938; Fax: +65 62342036

E-mail: [dss168@hotmail.com](mailto:dss168@hotmail.com); [dss-sales168@hotmail.com](mailto:dss-sales168@hotmail.com); [dannyk88@singnet.com.sg](mailto:dannyk88@singnet.com.sg)