



**Dedicated
Serving
System**

DS-MR16/VI

MOBILE REFRIGERATED CART

General Specifications & Features

- #304 Stainless steel interior & exterior.
- Bottom-mounted high ambient 43°C refrigeration system, using R134a refrigerant, generating 1584 BTU (399 Kcal) per hour.
- Ultra low energy consumption.
- Zero ODP injected polyurethane insulation for environmental protection.
- Factory preset refrigerator temperature at +1 / +4°C.
- Electronic controller with a large LCD display.
- Audio visual temperature alarms come as standard, along with HACCP capability.
- Automatic defrost (hot gas defrost – refrigerator) to help minimizing service needs.
- Coated evaporator and vaporiser coil.
- Safety cut out switch – heated.
- Color-coded control panel (in blue color for the refrigerated cart) for easy identification of the purpose of the cart.
- Interior curved corners/edges for easy cleaning and hygiene & sanitation purpose.
- Gastronorm shelving system with anti-tilt slides.
- Mechanical parts are easily accessible for quick servicing & maintenance.
- Four (4) integrated stylish door handles on each side of the cart for easy transportation.
- Door handle is equipped with lock.
- Four (4) heavy-duty swivel castors.
- Full-perimeter bumper guard to ensure heavy duty use and protection.
- Designed to adapt to 1/1 GN pans or 1/2 GN pans. This model is quite practical and suitable for catering & banqueting services.



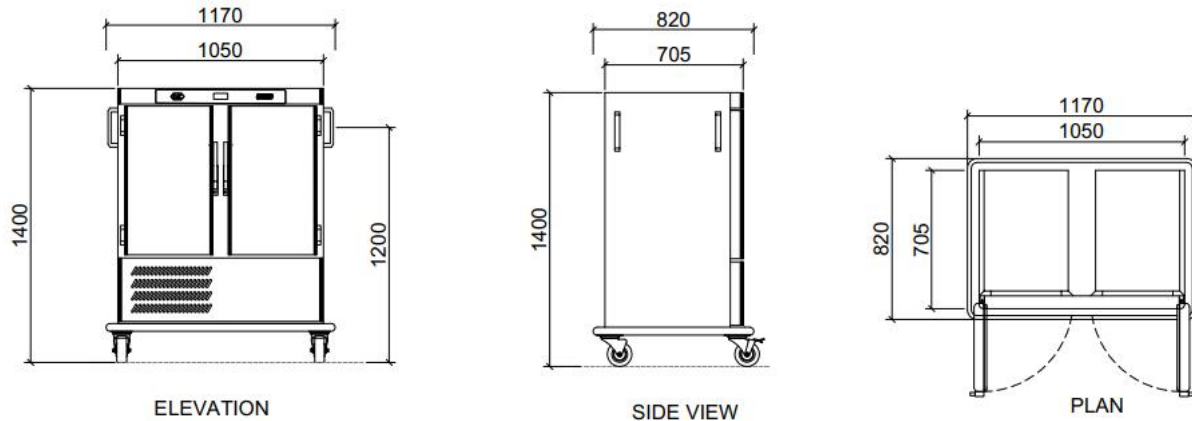

Technical Specifications

Model	Pan / Product Capacity	Temperature	Refrigerant	Voltage	Phase	Cycle	Amps	Watts	Cord Length
DS-MR16/VI	(16) 1/1 GN pans or (32) 1/2 GN pans	+1 / +4°C	R134A	220-240V	1	50/60 Hz	2.5	286	2.5M

Dimensions & Weights

Interior Dimensions (W x D x H in mm)	Exterior Dimensions (W x D x H in mm)	Product Net Weight (kg)	Shipping Dimensions with Standard Packing (W x D x H in mm)	Shipping Weight with Standard Packing (kg)	Shipping Dimensions with Wooden Crating (W x D x H in mm)	Shipping Weight with Wooden Crating (kg)
970 x 655 x 800	1170 x 820 x 1400	145	1175 x 825 x 1450	150	1220 x 870 x 1550	175

INSTALLATION REQUIREMENTS

- Cart must be installed level.
- Cart must not be installed in any area where it may be affected by steam, grease, dripping water, extreme temperatures, or any other severely adverse conditions.

CLEARANCE REQUIREMENTS

Full perimeter bumper accommodates all clearance requirements.

Note: Three (3) years international warranty on parts.



DK Resources International Ltd

Marketed & Distributed by:

DK Resources International Ltd.

Tel: +852 68906866; +65 90180938; Fax: +65 62342036

E-mail: dss168@hotmail.com; dss-sales168@hotmail.com; dannyk88@singnet.com.sg