



**Dedicated
Serving
System**

DS-CH-MH12/NV

MOBILE HOT HOLDING CART

Features & Advantages of CIRCUM HEAT®

- CIRCUM Heat (patented) technology is being used in the wide range of DSS holding cabinets and banquet carts. Heating pads (heating elements) are located in the side walls of the holding cabinets and banquet carts to provide and ensure an even and gentle heat distribution throughout the entire cabinet.
- No water is needed and required in the DSS holding cabinets and banquet carts while using the CIRCUM Heat. Adding water vapor to held foods lessens taste and can also result in “washed out” or drying out food before it’s even served. Gentle radiant heat in a sealed and static holding environment is all that is needed to keep the food hot, flavorful and ready to serve for hours.
- CIRCUM Heat equipment will help saving more energy and money as CIRCUM Heat consumes only one-half to even one-third of the energy of any conventional method of heating/warming equipment’s.
- CIRCUM Heat keeps foods at safe and even temperatures while retaining the maximum amount of natural food product moisture as there is no fan and no high-density heating elements that are used in the CIRCUM Heat holding cabinets and banquet carts. Using fan and high-density heating elements will result in drying out the food products and changing the texture of the food products to be served.
- Side racks with integrated gaps ensure better air circulation and even temperature distribution.
- Temperature variance in the CIRCUM Heat products is very minimal, only a few degrees from top to bottom of the cabinet, while temperature fluctuations in almost all other top brands’ are easily over 15 degrees and in some even up to 25 degrees.
- Designed to adapt to 1/1 GN pans. This model is quite practical and suitable for catering services.



Shelves are optional for any operational needs.

General Specifications

- #304 Stainless steel interior & exterior.
- Ultra low energy consumption with a thermostatic control.
- One (1) single compartment and one (1) temperature control
- Zero ODP injected polyurethane insulation for environmental protection.
- Factory preset temperature to operate between 76°C and 86°C to have a better control on temperature while having rooms for a possible adjustment of temperature within in a safe temperature range.
- Electronic controller with a LCD display.
- Safety cut out switch – heated.
- Color-coded control panel (in red color for the heated cabinets) for easy identification of the nature of the cart.
- Interior curved corners/edges for easy cleaning and hygiene & sanitation purposes.
- Gastronorm shelving system with anti-tilt slides.
- Mechanical parts are easily accessible for quick servicing & maintenance.
- One (1) set of stylish and robust door handles.
- One (1) lockable self-closing doors.
- Door handles are equipped with lock.
- Four (4) heavy-duty casters; two (2) swivel and two (2) with brake.
- Full-perimeter bumper guard to ensure heavy duty use and protection.



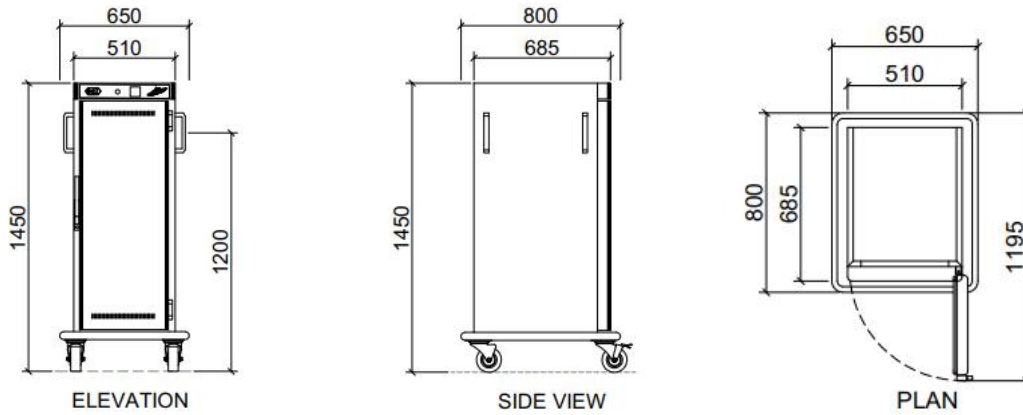

Technical Specifications

Model	Pan / Product Capacity	Temperature	Voltage	Phase	Cycle	Amps	Watts	Cord Length
DS-CH-MH12/NV	12 nos. 1/1 GN pans	+27 / +93°C	220-240V	1	50/60 Hz	8.1	1500	2000mm

Dimensions & Weights

Interior Dimensions (W x D x H in mm)	Exterior Dimensions (W x D x H in mm)	Product Net Weight (kg)	Shipping Dimensions with Wooden Crating (W x D x H in mm)	Shipping Weight with Wooden Crating (kg)
380 x 580 x 1200	650 x 800 x 1450	113	860 x 940 x 1600	128

INSTALLATION REQUIREMENTS

- Cart must be installed level.
- Cart must not be installed in any area where it may be affected by steam, grease, dripping water, extreme temperatures, or any other severely adverse conditions.

CLEARANCE REQUIREMENTS

Full perimeter bumper accommodates all clearance requirements.

Note: Three (3) years international warranty on parts.



Marketed & Distributed by:

DK Resources International Ltd.

Tel: +852 68906866; +65 90180938; Fax: +65 62342036

E-mail: dss168@hotmail.com; dss-sales168@hotmail.com; dannyk88@singnet.com.sg